

PILASTRON N. 3

INCAMICIATURA PILASTRI

COLLEGAMENTO FRA TRAVI PRINCIPALI E PILASTRI

STATO ATTUALE

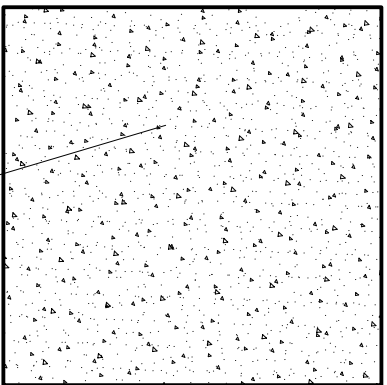

pilastro 50x50



PIANTA PILASTRI

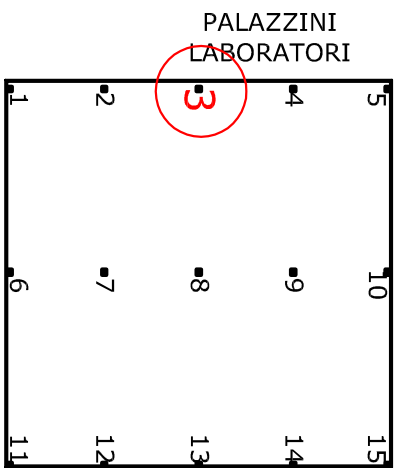

PALAZZINI
LABORATORI

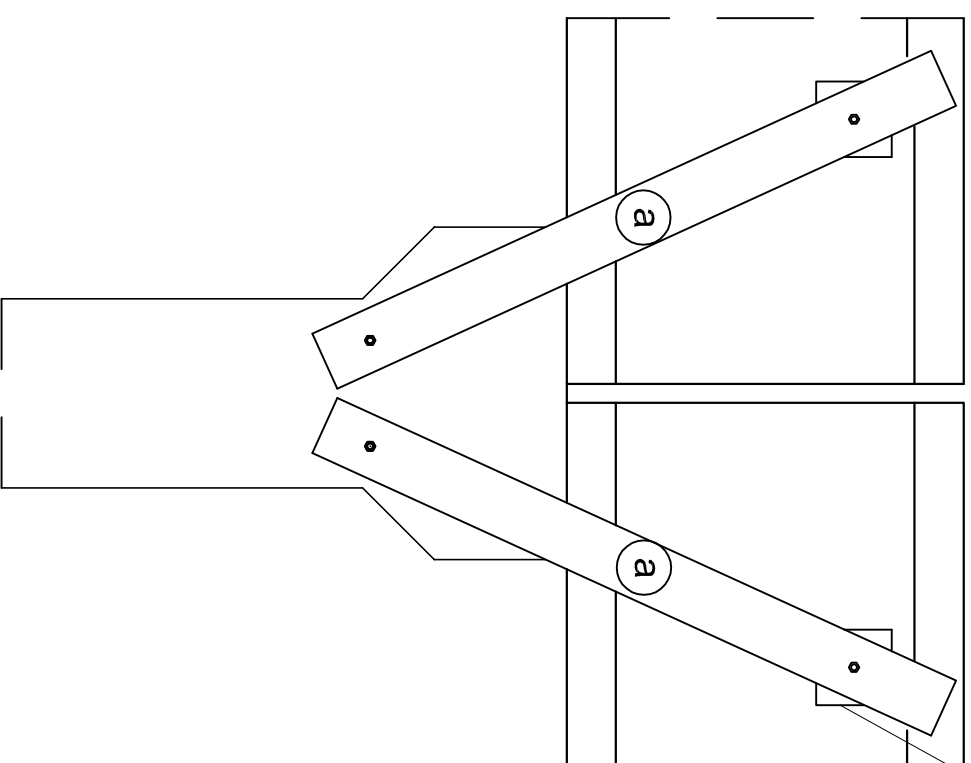
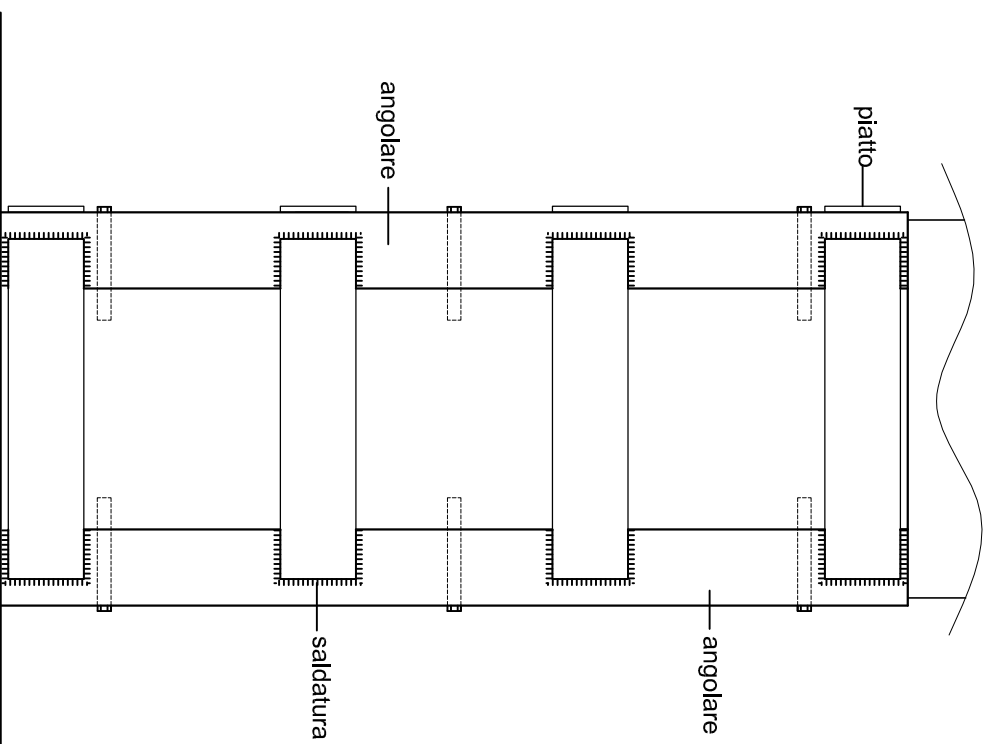

Tamponi in materiale plastico
ad alta resistenza
200x200 mm x
(spessore da rilevare)

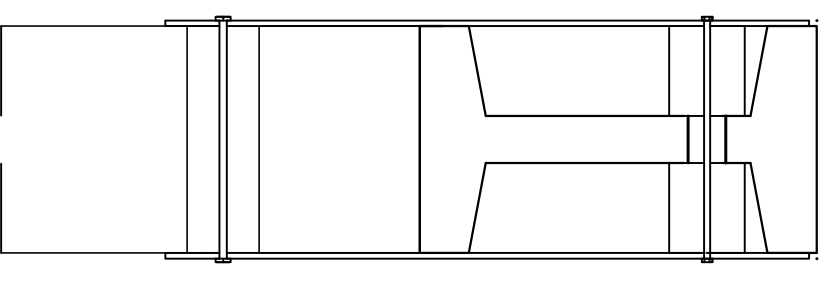

N. 4 PIATTI
450x8x h100

INTONACO
ARMATO
RETE
DA
INTONACO

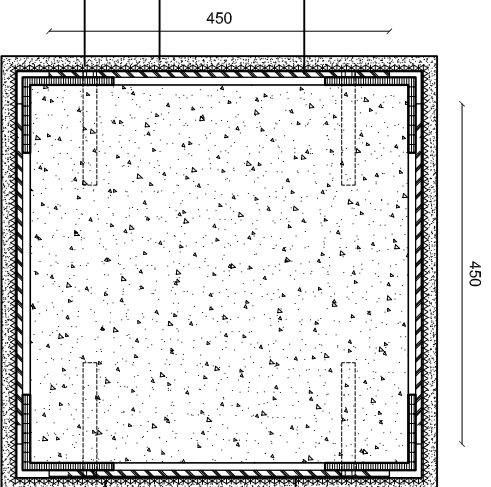

N. 4 PIATTI
400x10x h100

INTONACO
ARMATO
RETE
DA
INTONACO

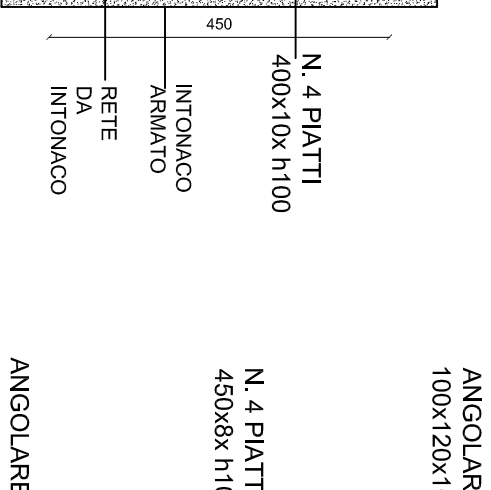

N. 4 PIATTI
450x8x h100

ANGOLARE
100x120x10xh1200

ANGOLARE
100x120x10xh1200

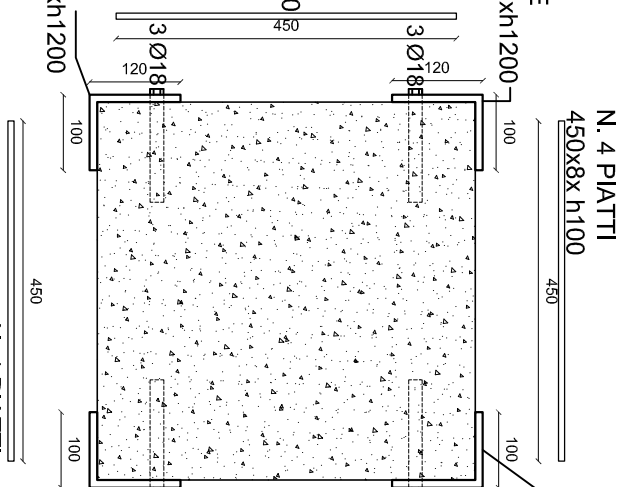

N. 4 PIATTI
450x8x h100

ANGOLARE
100x120x10xh1200

ANGOLARE
100x120x10xh1200

N. 4 PIATTI
450x8x h100

ANGOLARE
100x120x10xh1200

ANGOLARE
100x120x10xh1200

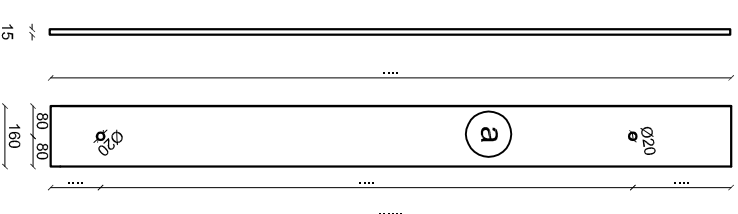
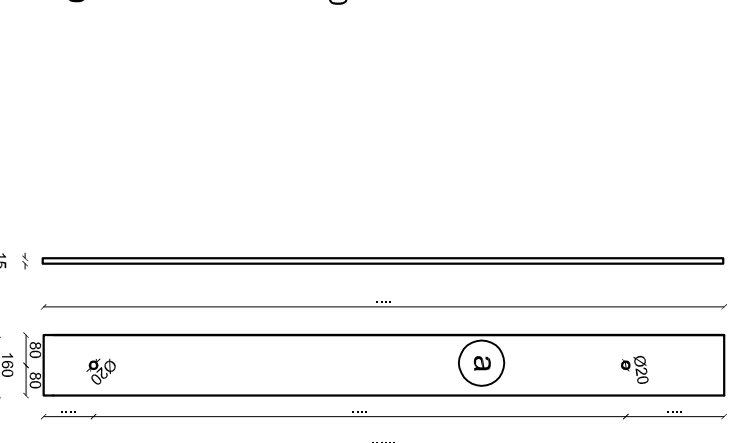

LUNGHEZZE
DA
VERIFICARE

Studio C

di Ing. Chierici Paolo

43126 Parma - Via Reggolo, 8
Tel. 0521.782779
E-mail: studioc.parma@libero.it
P. IVA 02733800342